



Apple][Computer Information

IWM Floppy Disk I/O Controller Info

UniDisk Floppy Disk Power Usage Oscilloscope Screens

Apple Computer, Inc. -- March 9, 1983

INCLUDES DISK II INTERFACE CARD SCHEMATIC

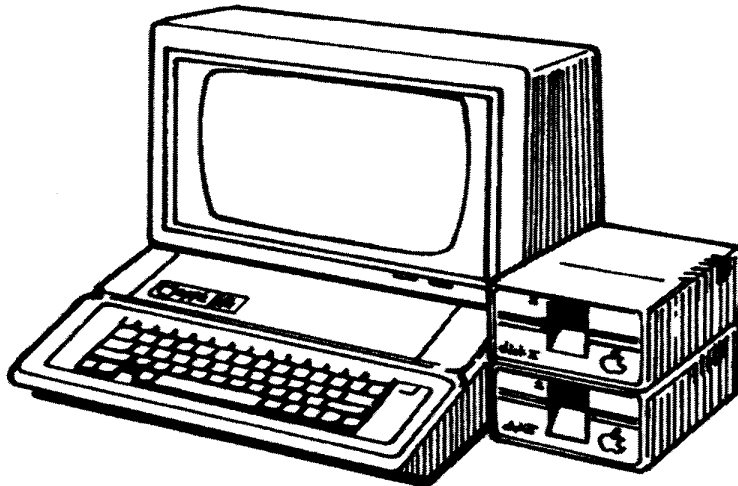

SOURCE

Brutal Deluxe Software web site -- www.brutal-deluxe.fr

31 December 2008

S.T. 3-9-83

UNIDISK FLOPPY DISK

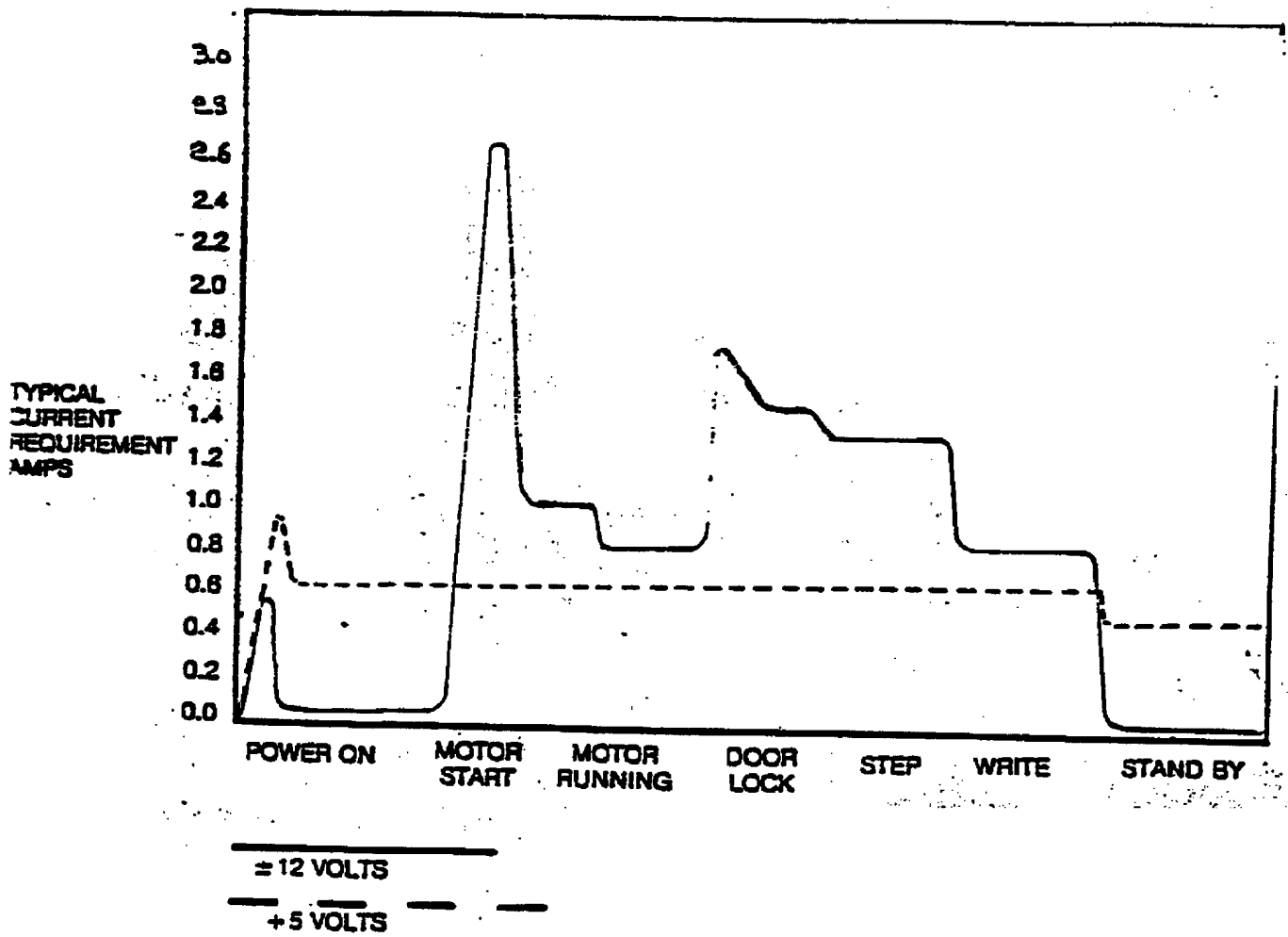
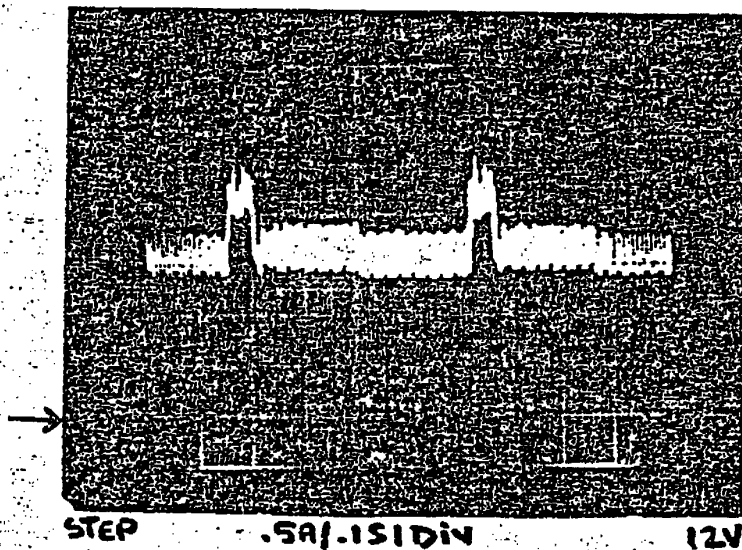
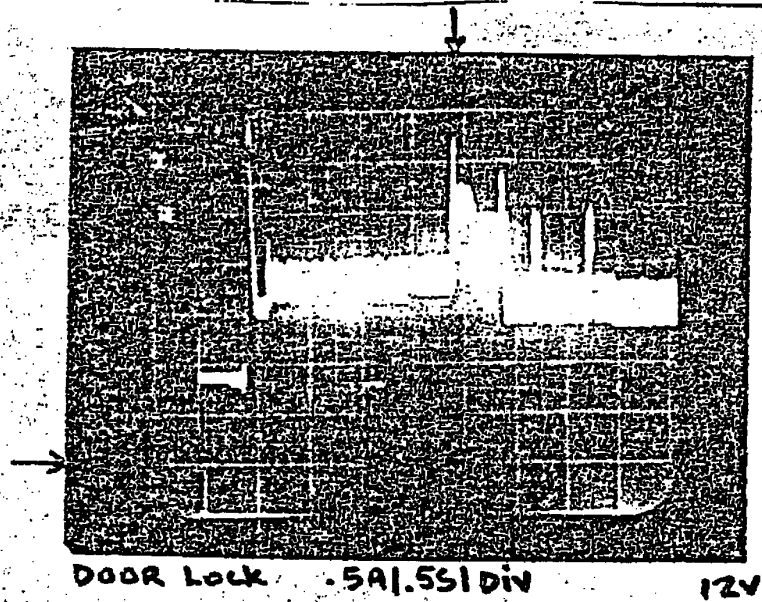
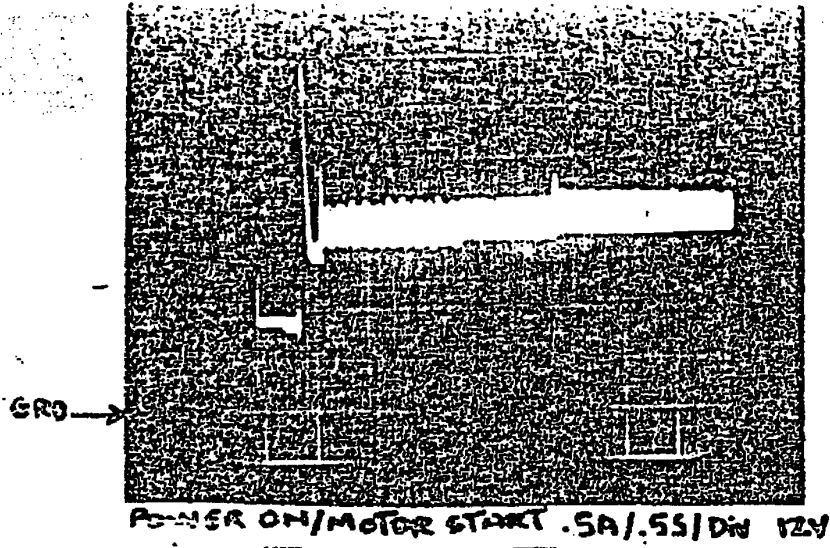
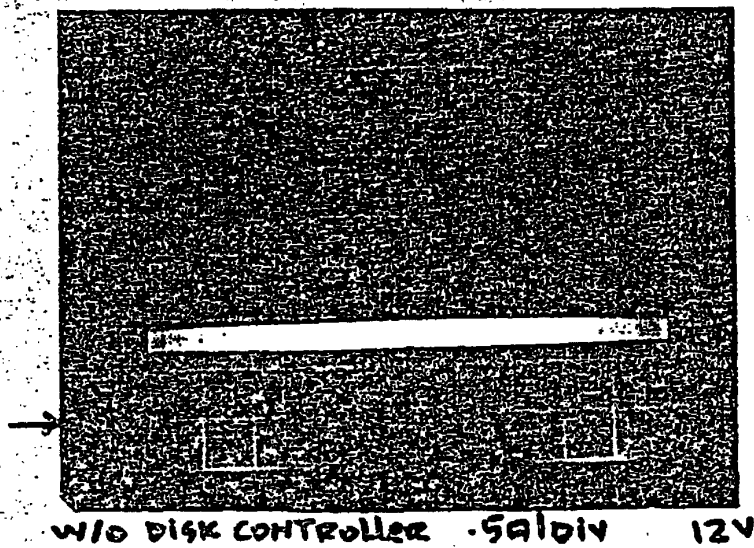
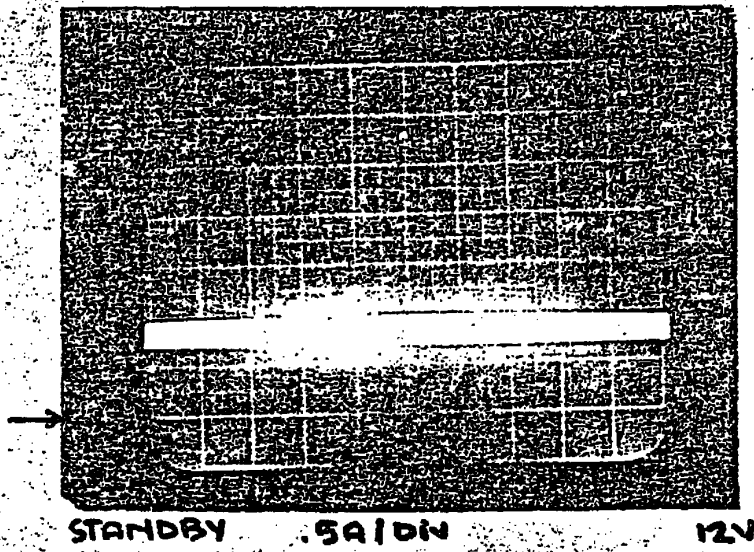
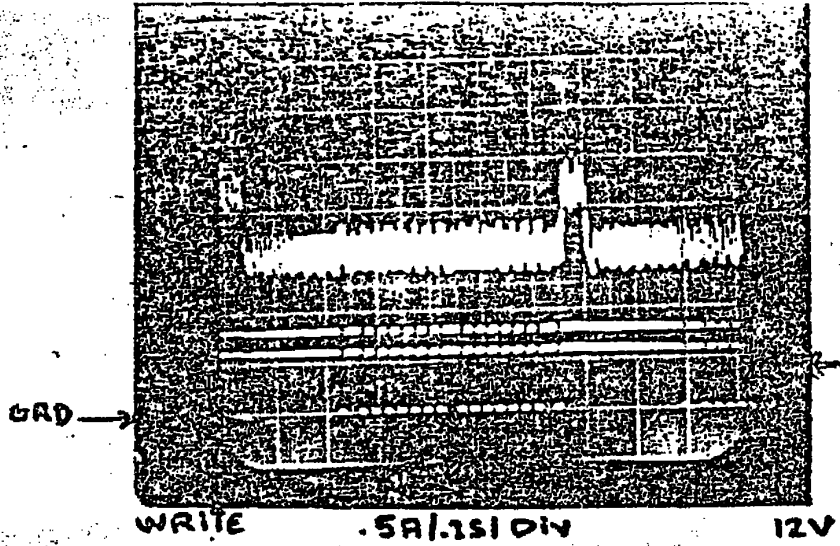

TABLE 1. DC POWER REQUIREMENTS

1/6



2/6



3/6

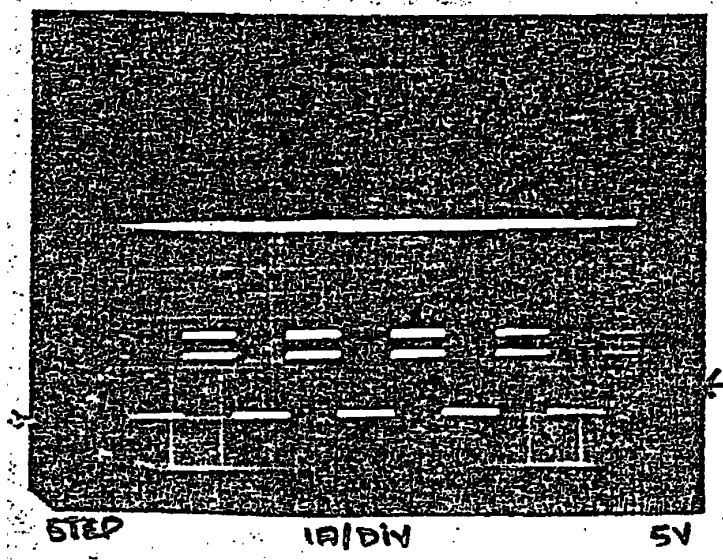
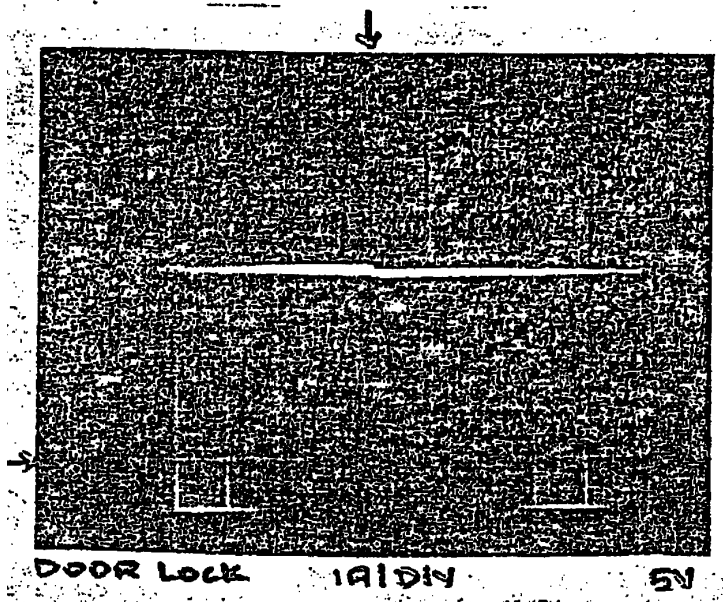
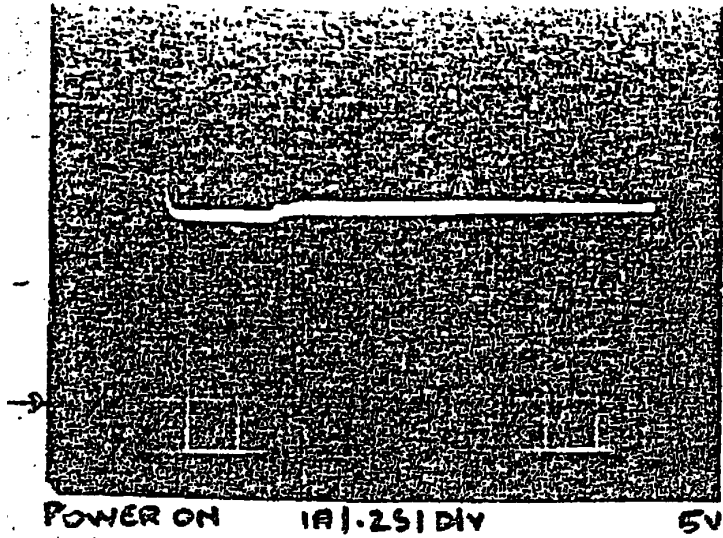

4/6

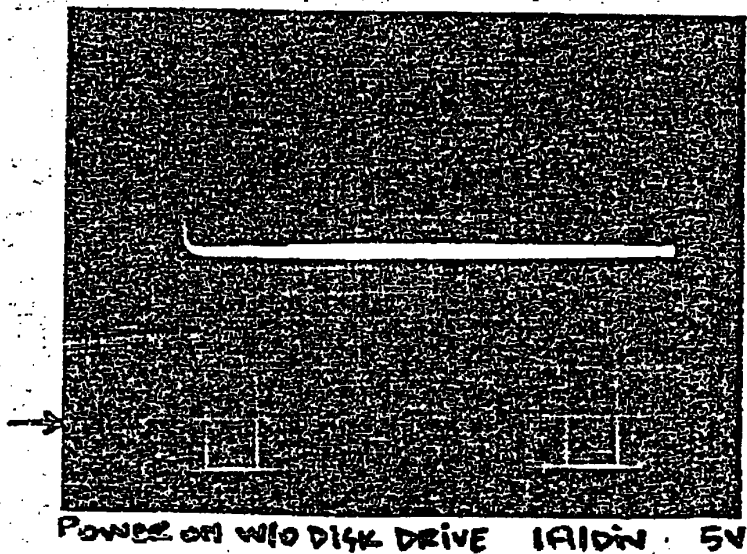
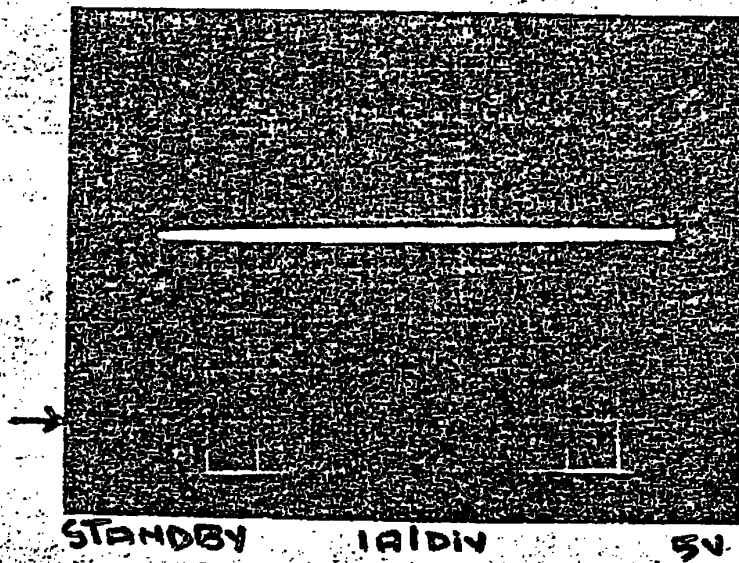
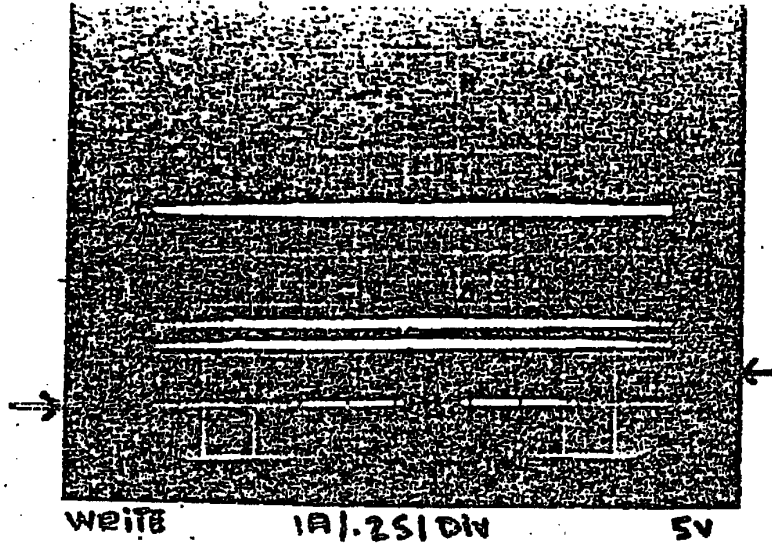

5/6

CIRCUIT SCHEMATIC: DISK II INTERFACE

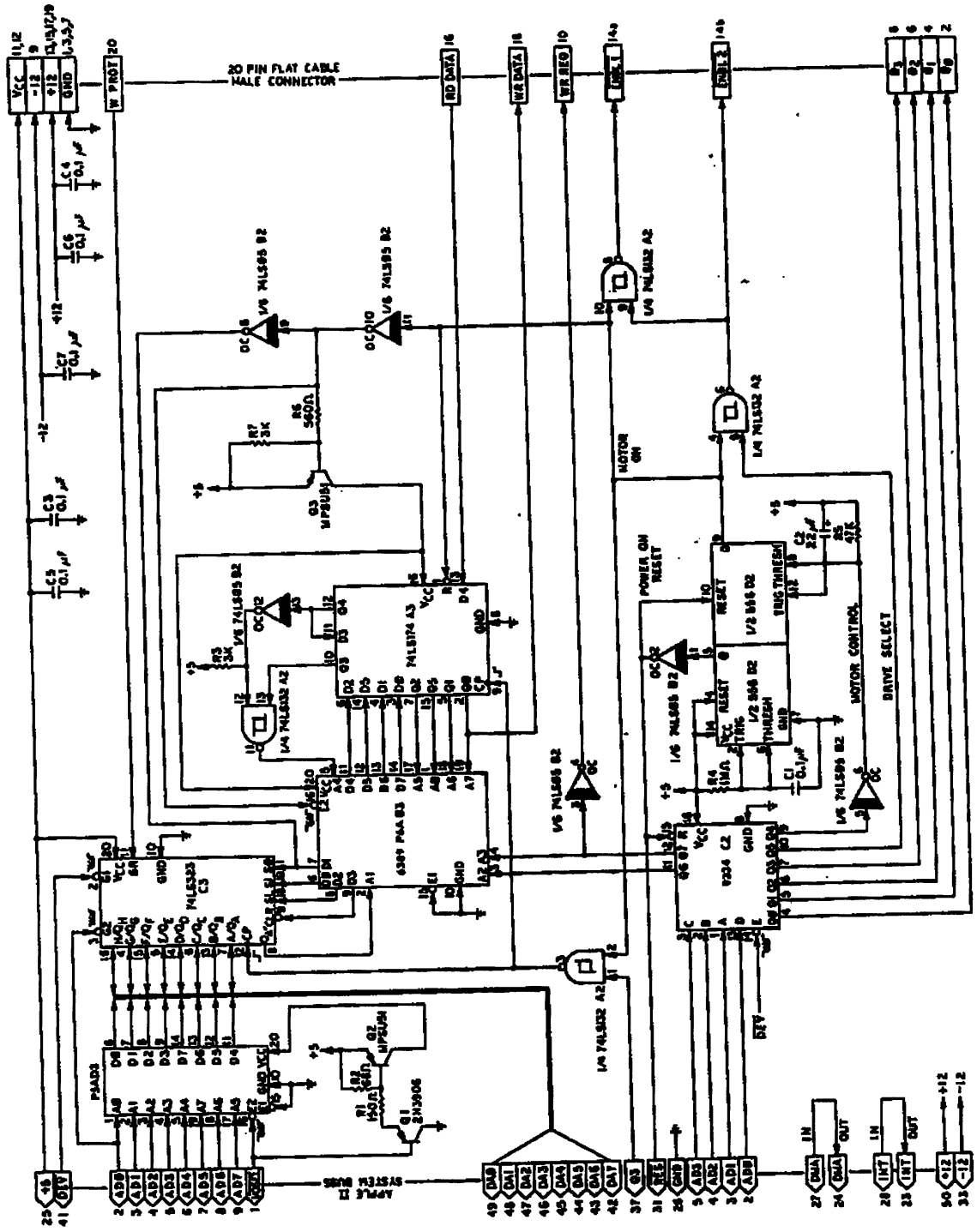

PATENT PENDING © Apple Computer Inc. 060-0005-00

6/6